

- 1/2-20 Threaded Stud Input w/Nut
- BNC (Amphenol) Output

4X ϕ .28 [7] THRU
ON A 2.75 [70] BOLT CIRCLE

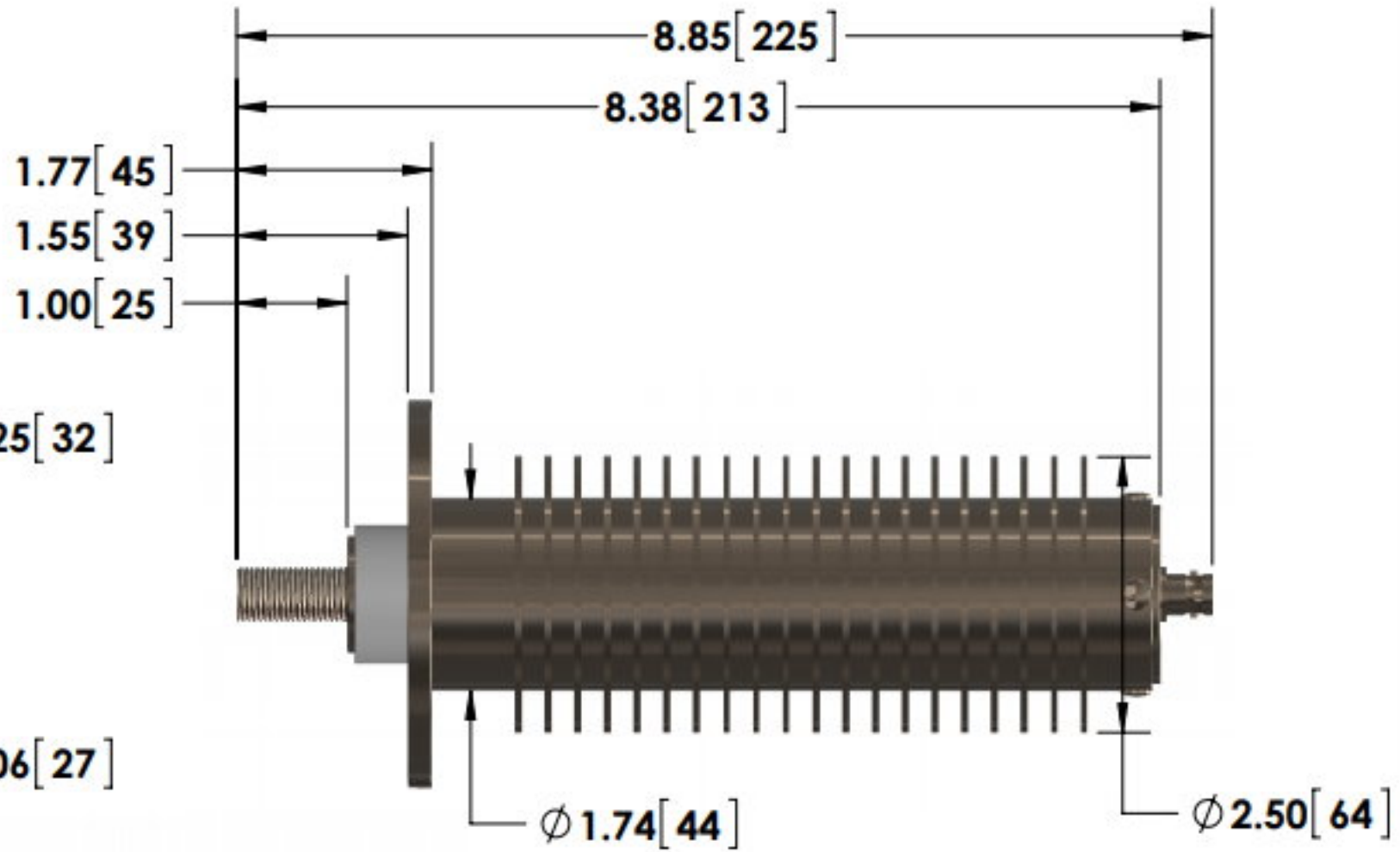

Specifications subject to change without notice.

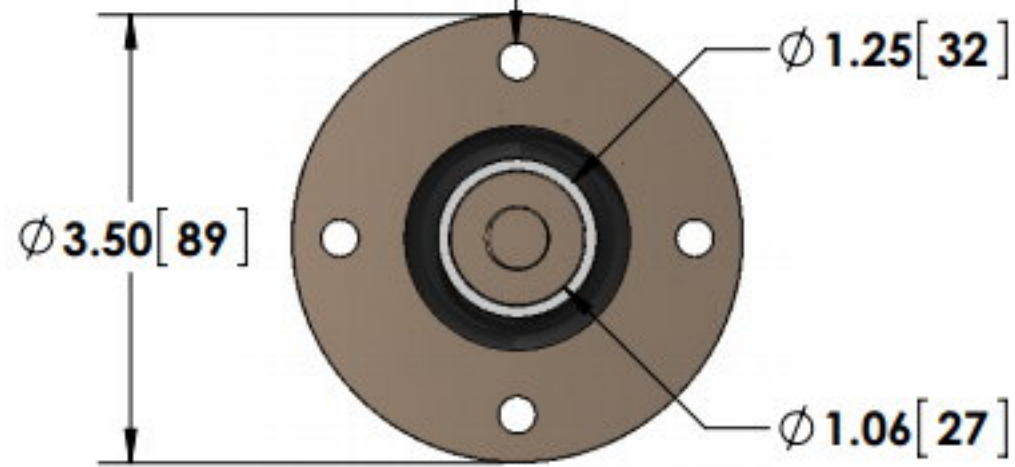

T & M RESEARCH PRODUCTS, INC.

TITLE:

F SERIES - 300 Watt Units

DIMENSIONS:

inch [mm]

DATE:

03-27-2015